

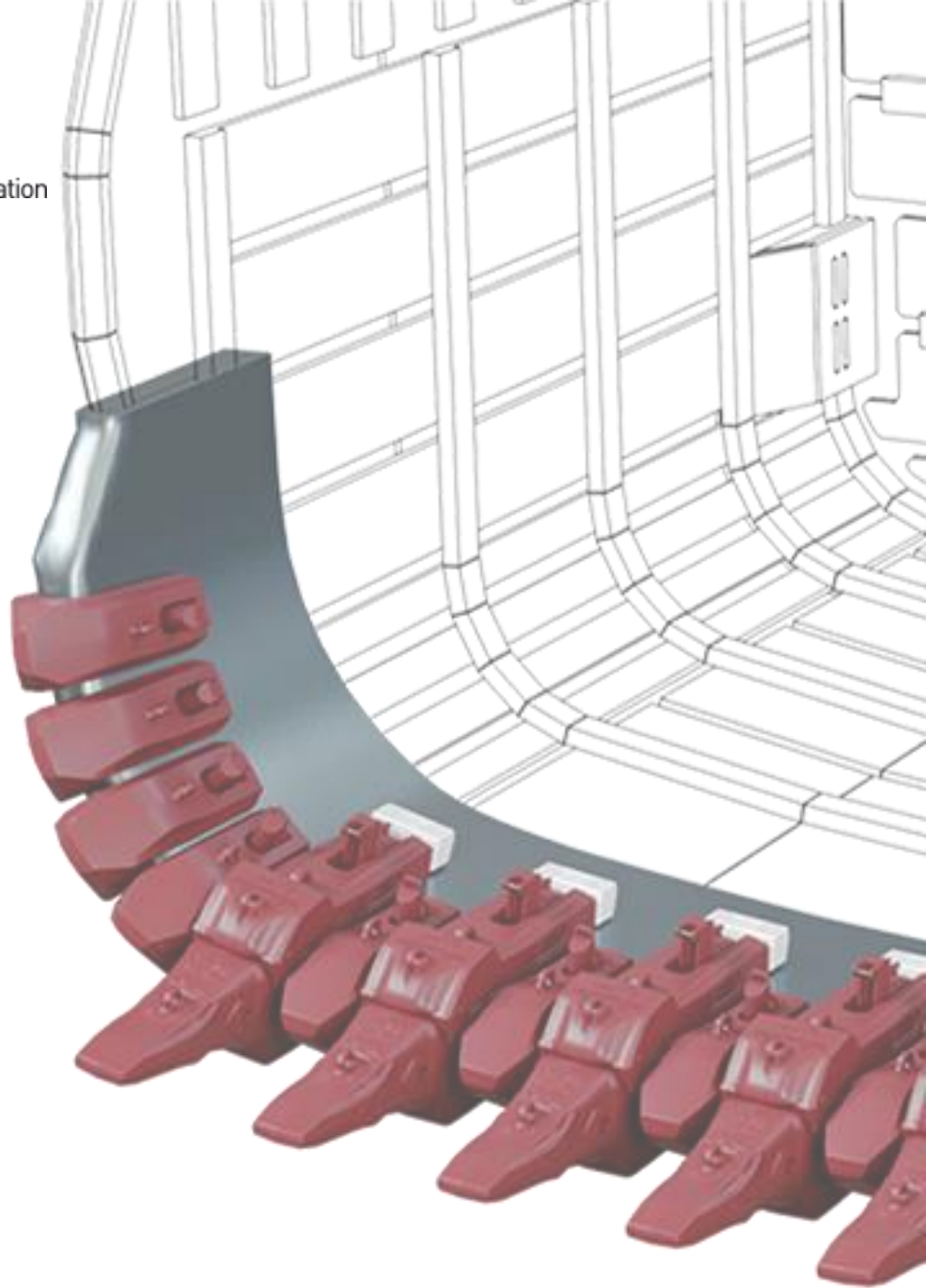

MTG

No limits innovation



INS.2.6.6

Weld-on Bridges for VEEMET ROPE SHOVELS Adapters

Installation procedure

DISCLAIMER

© MTG, all rights reserved

The brands identified with an asterisk do not belong to METALOGENIA S.A. and this organization refers to them only to identify the destination of its products, without there being any relationship between METALOGENIA S.A. and the legitimate owners of any such brands.

Copy right: It is strictly forbidden for any person not belonging to MTG to distribute all or any part of the material set out in this document unless they are authorized to do so.

Liability: To ensure the correct use and handling of the MTG products without risk, please carefully read the corresponding service instructions set out on the MTG website. MTG will not be held liable for damages, loss, injury, or death arising from incorrect use or failure to heed the provisions of this guide. Similarly, MTG will not be held liable for damages caused due to the faulty installation or handling of its products. MTG likewise declines all liability for recommendations related to the use or handling of MTG products set out in documents not expressly authorized by MTG.

1. SAFETY

The practices described in this manual can be taken as guidelines for operating safely in many conditions and in addition to the safety standards that are current and enforceable in your area or region.

Your safety and the safety of third parties is the result of putting into practice your knowledge of the correct operational procedures.

Attention, when performing the work described in these instructions, always work safely and use the personal protection elements required to minimize or avoid injury. Always wear:



**HARD
HAT**



**SAFETY
GLASSES**



**EAR
PROTECTION**



**STEEL TOED
BOOTS**



**PROTECTION
GLOVES**

To avoid eye injury, always wear safety goggles or a protective mask when using any equipment, hammer or similar tool. When equipment is under pressure or when objects are struck, chips or other debris can be thrown out. Make sure no one gets hurt by the debris that is fired before applying pressure or hitting an object. Wear eye protection that complies with ANSI Z87.1 and OSHA standards. Also wear hearing protection and gloves.

Lifting a heavy object can cause serious or fatal injury. DO NOT exceed the maximum rated capacity of lifting and positioning devices: Stay away from the area under a suspended load.



**LIFTING
LUG**

Make sure that the chain is not damaged and that the load is always balanced.

2. WELDING

Following is a quick reference on consumables that can be used to weld MTG products. For a complete reference on welding procedures, refer to the document entitled "General welding recommendations".

WELDING UNALLOYED & LOW ALLOYED FILLER CONSUMABLES

PROCESS	EN CLASS	AWS CLASS
SMAW	EN ISO 2560-S E42X	E70X ACCORDING TO A5.1 OR EQUIVALENT UNDER A5.5
GMAW	EN ISO 14341-A G42X	E70C-X ACCORDING TO A5.18 OR EQUIVALENT UNDER A5.28
	EN ISO 14341-A G46X	E70S-X ACCORDING TO A5.18 OR EQUIVALENT UNDER A5.28
FCAW	EN ISO 16834-A T42X	E7XT-X ACCORDING TO A5.20 OR EQUIVALENT UNDER A5.29

CONSUMIBLES DE RELLENO INOXIDABLES AUSTENÉTICOS

PROCESS	AWS CLASS
SMAW	E307-X ACCORDING TO A5.4
GMAW	ER307T-X ACCORDING TO A5.22
	ER307 ACCORDING TO A5.9
FCAW	307-X ACCORDING TO A5.22

NOTE: "X" MAY STAND FOR ONE OR SEVERAL CHARACTERS.

3. IMPORTANT

Read the full document before starting any operation, as there may be some steps that may require previous verifications/operations.



The installation of bridges for HD adapters requires that the station where they are to be installed has been previously calibrated using MTG gauges.

These instructions are a generic procedure for all VeeMet adapters for rope shovels, regardless of the lip standard (WH/BK), and adapter size.

4. INSTALLATION PROCEDURE

CAUTION: The installation of MTG products for cable shovels may require welding and/or grinding of the existing lip to return it to its original geometry and thus ensure proper tightening and performance. 

To perform the reconstruction/recalibration of lips, it is mandatory to follow the MTG reparation instructions for rope shovels which describe the proper procedures for recovering the lip geometry by using MTG gauges. Please contact technical.services@mtg.es for further information.

4.1 Adapters' bridges must rest at the same level of the adapter lip rear pads, so it will be necessary to build a bridge bed at the top and at the bottom lip surface before welding the bridges.

The following dimensions can be used as a guide to build the bridges' beds.

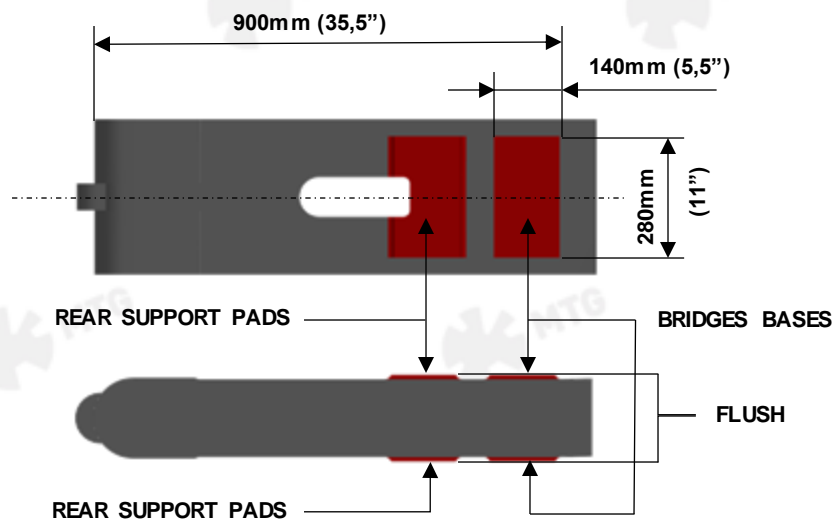

For the bridges' beds building up follow the next steps:

- In case of finding a gap bigger than 10mm - 3/8 in., our recommendation is to fill the gap with shims. Go directly to step 4.3, section "A"
- Grind surfaces to be welded or rebuilt on the lip to remove dirt, rust, paint, or other impurities that may affect the quality of the weld.
- Check the area to be built with penetrating liquids or magnetic particles in search of cracks.
- Preheat according to lip manufacturer specifications.
- The welding passes must be performed horizontally. Keep the temperature between passes below 200°C - 400°F.
- Deposit excess welding material to later grind to the required shape and dimensions.
- Deposit the welding passes away from each other to prevent the base material from overheating in an area.

- The sequence and disposition of the weld beads would be as follows:

A) Deposit a first layer of weld beads following the disposition shown below.

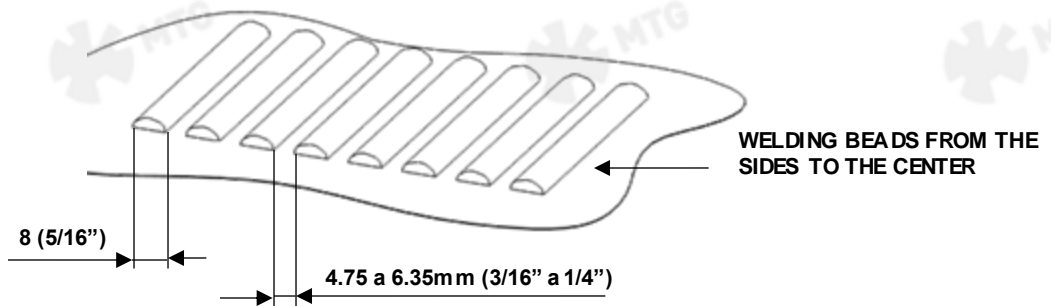

B) Weld a second "layer" of beads according to the following figure.

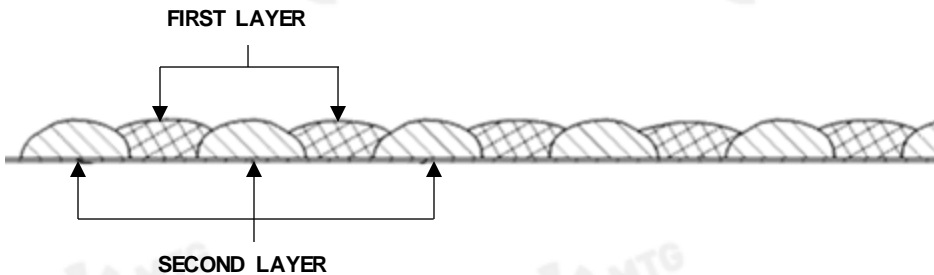

C) If more than one layer is required for the bridges' beds building, deposit the second layer according to the following figure.

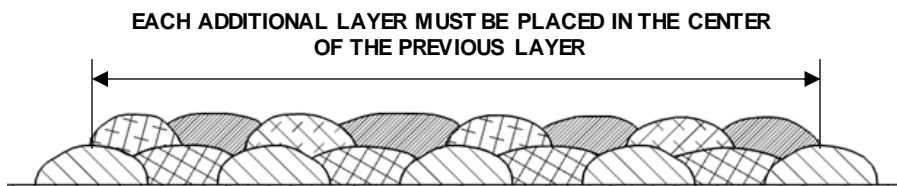

D) Grind the surface of the resulting bases according to the specific needs of size and shape.

- 4.2** Insert the gauge into the adapter station to be converted being sure that the gauge is fully inserted and that the gauge has the bridge's positioners installed on it. Insert the bayonet through the hole to keep the gauge position

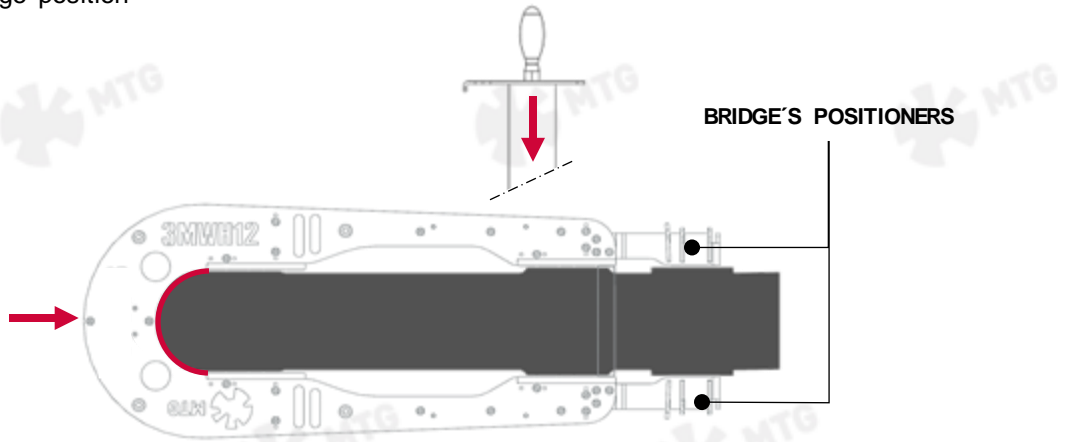

- 4.3** Place the bridge on its corresponding gauge housing being sure that the bridge is contacting the previously built bridge's beds at the bottom and the gauge's plate at the front as the picture shows. In case the bridge does not contact the previously built pad, add welding to the pad to bring this gap to zero.

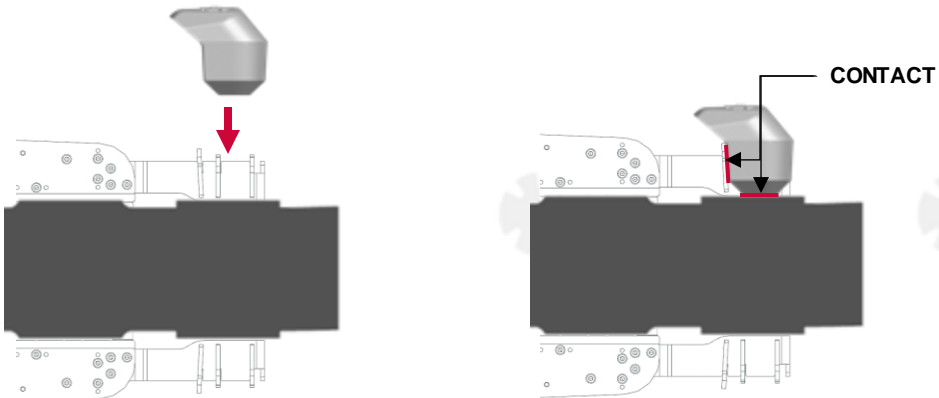

In case of finding a gap greater than 10mm – 3/8 in, follow this sequence:

- A)** Cut shims of the desired thickness and dimensions according to the bridge legs.
- B)** Preheat at a minimum of 175°C -347°F both, bridge, and shims in order to tack weld them together.

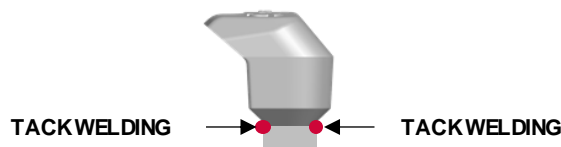

- C)** Preheat the lip according to the manufacturer's specifications and weld the Bridge + shims assembly to it, following STEP 4.4.

4.4 Preheat bridge and lip to a temperature between 175°C to 200°C - 347°F to 392°F and tack weld the bridge to the lip.

4.5 Proceed with the bridge to lip welding by fulfilling the bridge welding grooves. **DO NOT WELD AT BRIDGES' INNER SURFACES.** Be sure that the welding procedure comply with what is specified in the document entitled "General welding recommendations".

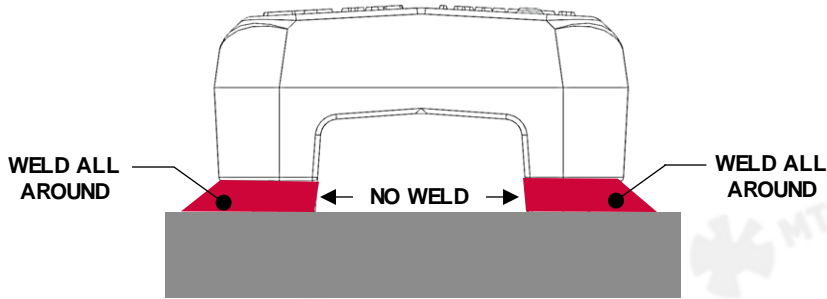

4.6 Repeat the operation with the bottom bridge and in the rest of stations.



Service Instructions

The latest welding recommendations and assembly / disassembly instructions can be found online:

www.mtgcorp.com/manuals

Please contact Technical Services in case of questions:

technical.services@mtg.es



MTG HEADQUARTERS

Carrer d'Àvila, 45
08005 Barcelona (Spain)
(+34) 93 741 70 00
info@mtg.es

MTG NORTH AMERICA

4740 Consulate Plaza Drive
Houston, TX 77032 (USA)
+1 (281) 872 1500
info@mtgcorp.us

MTG AUSTRALIA

16 – 18 Thorpe Close
Welshpool, WA, 6106 (AUS)
+61 8 6248 6513
Info.australia@mtg.es