



**MTG**

No limits innovation



**INS.2.1.1**

# **TERRA Cast Lip**

Installation procedure

## DISCLAIMER

### © MTG, all rights reserved

The brands identified with an asterisk do not belong to METALOGENIA S.A. and this organization refers to them only to identify the destination of its products, without there being any relationship between METALOGENIA S.A. and the legitimate owners of any such brands.

**Copy right:** It is strictly forbidden for any person not belonging to MTG to distribute all or any part of the material set out in this document unless they are authorized to do so.

**Liability:** To ensure the correct use and handling of the MTG products without risk, please carefully read the corresponding service instructions set out on the MTG website. MTG will not be held liable for damages, loss, injury, or death arising from incorrect use or failure to heed the provisions of this guide. Similarly, MTG will not be held liable for damages caused due to the faulty installation or handling of its products. MTG likewise declines all liability for recommendations related to the use or handling of MTG products set out in documents not expressly authorized by MTG.

## 1. SAFETY

The practices described in this manual can be taken as guidelines for operating safely in many conditions and in addition to the safety standards that are current and enforceable in your area or region.

Your safety and the safety of third parties is the result of putting into practice your knowledge of the correct operational procedures.

Attention, when performing the work described in these instructions, always work safely and use the personal protection elements required to minimize or avoid injury. Always wear:



To avoid eye injury, always wear safety goggles or a protective mask when using any equipment, hammer or similar tool. When equipment is under pressure or when objects are struck, chips or other debris can be thrown out. Make sure no one gets hurt by the debris that is fired before applying pressure or hitting an object. Wear eye protection that complies with ANSI Z87.1 and OSHA standards. Also wear hearing protection and gloves.

Lifting a heavy object can cause serious or fatal injury. DO NOT exceed the maximum rated capacity of lifting and positioning devices: Stay away from the area under a suspended load.



**LIFTING LUG**

Make sure that the chain is not damaged and that the load is always balanced.

## 2. WELDING

Following is a quick reference on consumables that can be used to weld MTG products. For a complete reference on welding procedures, refer to the document entitled "General welding recommendations".

### WELDING UNALLOYED FILLER CONSUMABLES

PROCESS	EN CLASS	AWS CLASS
<b>SMAW</b>	EN ISO 2560-S E42X	E70X ACCORDING TO A5.1 OR EQUIVALENT UNDER A5.5
<b>GMAW</b>	EN ISO 14341-A G42X	E70C-X ACCORDING TO A5.18 OR EQUIVALENT UNDER A5.28
	EN ISO 14341-A G46X	E70S-X ACCORDING TO A5.18 OR EQUIVALENT UNDER A5.28
<b>FCAW</b>	EN ISO 16834-A T42X	E7XT-X ACCORDING TO A5.20 OR EQUIVALENT UNDER A5.29

### WELDING AUSTENITIC STAINLESS FILLER CONSUMABLES

PROCESS	AWS CLASS
<b>SMAW</b>	E307-X ACCORDING TO A5.4
<b>GMAW</b>	ER307T-X ACCORDING TO A5.22
	ER307 ACCORDING TO A5.9
<b>FCAW</b>	307-X ACCORDING TO A5.22

NOTE: "X" MAY STAND FOR ONE OR SEVERAL CHARACTERS

## 3. IMPORTANT

- Read the full document prior to start any operation since there may be some steps which requires previous verifications/operations. 
- These instructions are a generic procedure for all MTG TERRA Cast Lips, regardless of size. For this reason, it is possible that the images contained in these instructions may differ from the parts to be installed in each case.
- Preheating temperature for any cut or weld is between 175°C and 200°C (347°F and 392°F)
- Maximum temperature allowed for any cut or weld is 250°C (482°F).
- Preferred method for preheating is by means of electric heating mats.
- Perform feathering on each tack weld (grind the beginning and the end of each tack).
- The maximum width for any weld, whether tacks or welding runs, including weaving movements is between 10 and 12 mm (3/8" and 1/2").
- Cool down rate should not exceed 55°C/h (131°F/h). After full welding completion, or after the completion of a specific area, or if the process is discontinued for any reason, weldments should be covered with thermal blankets to ensure a slow cool down.
- Die penetrant or magnetic particles inspection to be conducted after 48h to 72h of the welding completion.
- For further information, see the document entitled "General welding recommendations".
- The lifting lugs are not intended to lift the bucket once the castlip is welded.

## 4. INSTALLATION PROCEDURE

### 4.1 REMOVING THE EXISTING LIP

**4.1.1** To ensure that the geometry of the bucket/jaw is maintained once the lip to be replaced has been removed, an internal structure must be built. Weld structural bars or beams (A) across the sides of the bucket/jaw and other structural bars or beams (B) from the bottom plate of the bucket/jaw (just behind the lip-to-bucket weld joint) to the sides of the bucket/jaw.

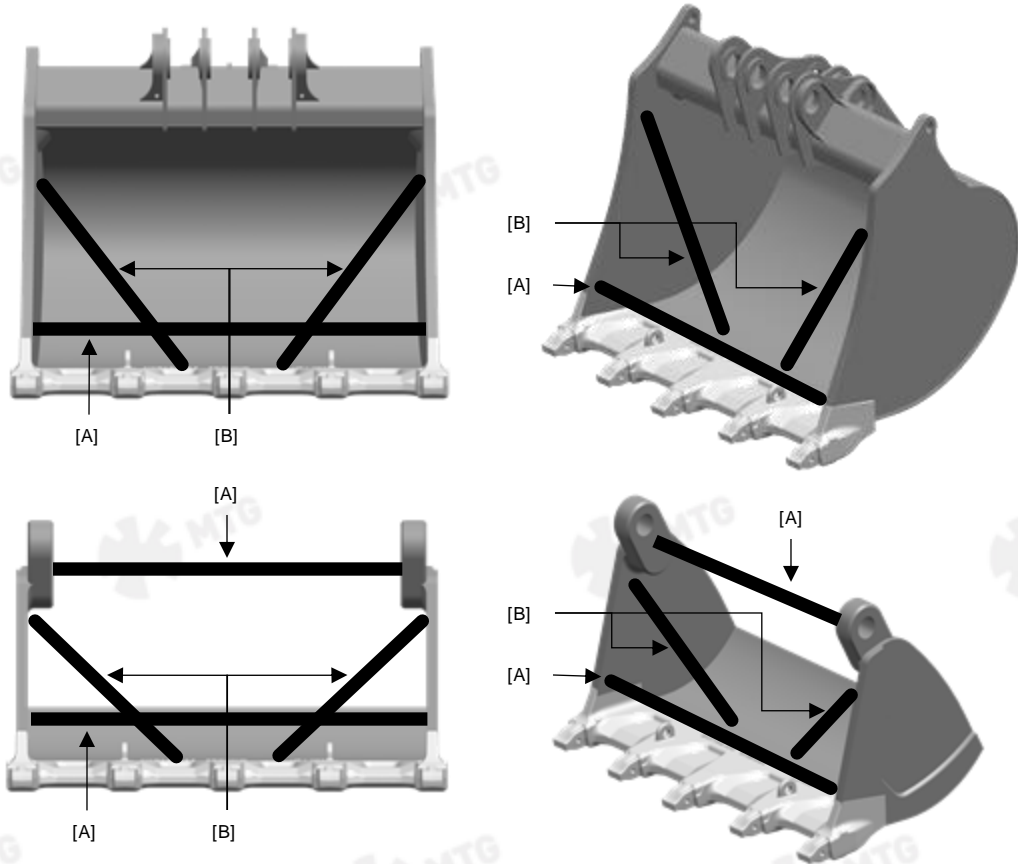

**4.1.2** Mark cut lines based on the weld of the lip to be replaced and compare dimensions with the new lip. For backhoe buckets, these cut lines must be corrected if the radius of the most advanced tooth is greater than the existing one. Proceed with cutting with torch and remove the used lip.

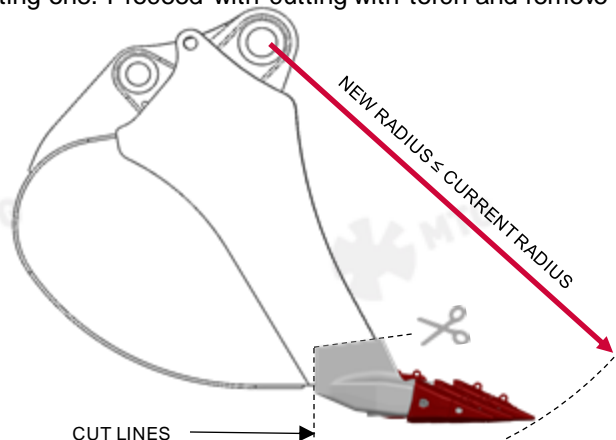

## 4.2 PREVIOUS PREPARATION FOR THE INSTALLATION OF THE NEW LIP

4.2.1 Perform welding chamfers on the bucket plates after cutting the existing lip.

4.2.2 Chamfer the side plates to generate the welding grooves. Chamfers must be 63.5mm (2 1/2") x 45° per side (inside and outside).

4.2.3 Chamfer the bottom plate of the bucket from the inside of it. Thicker plates will need to be chamfered on both sides, from the inside and outside of the bucket.

4.2.4 Clean all chamfers and areas to be welded. Weld surfaces must be free of traces of slag from torch cutting.

4.2.5 Verify by non-destructive methods that the chamfers generated, and adjoining areas are free of cracks.

4.2.6 MTG's cast lip is served with an anti-rust primer. This primer must be removed at the areas to be welded and their surroundings prior to start any welding. The surfaces to be welded must be sufficiently clean so that there is no residues that may contain hydrocarbons or any other impurity that may negatively affect the resistance of the welds.

4.2.7 Place and secure the bucket or jaw as shown in the figure to ensure that the lip is placed in a safe position. This position will allow for easy installation and correct alignment of the lip with the help of an overhead crane. This is an excellent position for achieving the proper preheating temperature, tack weld the lip into its final position, and performing the weld.

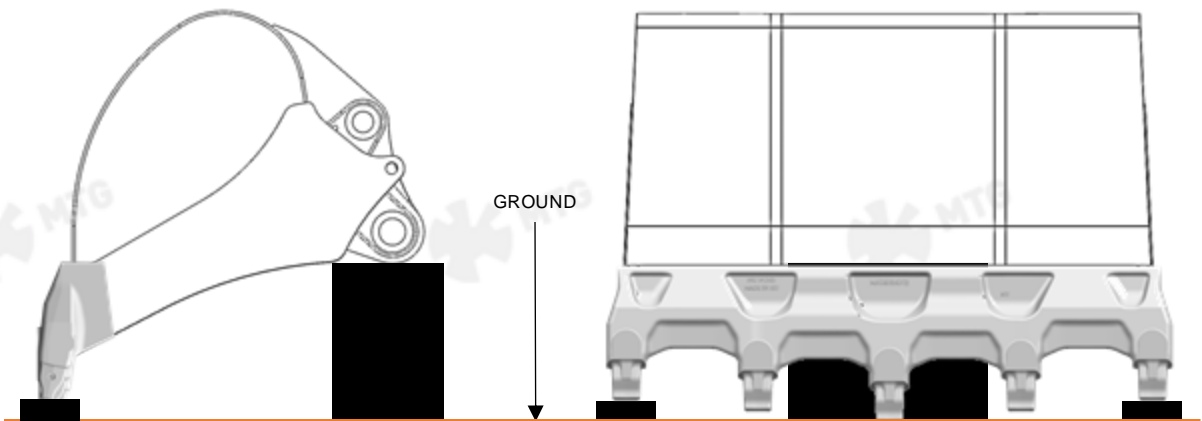

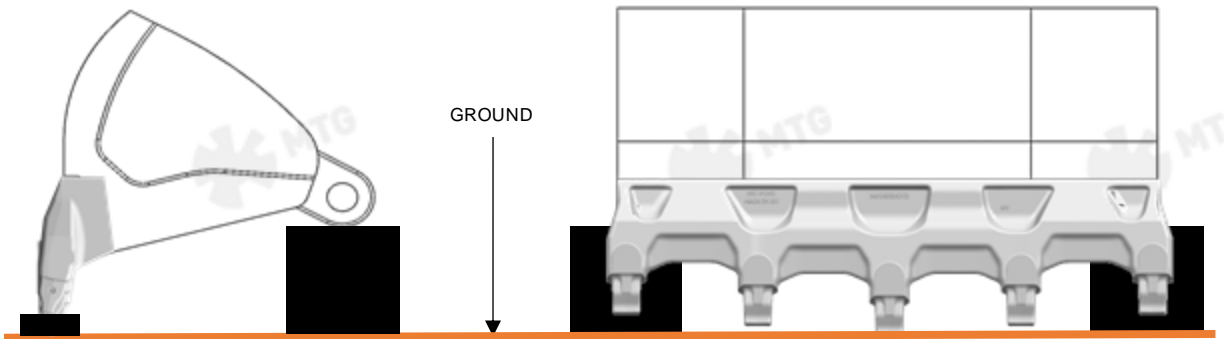

### 4.3 PREHEATING

**4.3.1** The recommended method of reaching preheating temperature is by electric heating mats. If flame methods are used, large diameter heating nozzles should be used and well distributed over the entire lip to ensure even application of heat and prevent overheating in thinner areas.

The preheating temperature must be between 175°C and 200°C (347°F and 392°F) for both the lip and the bucket/jaw plates. This temperature must be set in all regions to be welded and must be reached at 100mm away from any weld groove.

### 4.4 FILLING MATERIAL

**4.4.1** In accordance with the instructions given in the document entitled: General welding recommendations.

### 4.5 POSITIONING AND TACK WELDING

**4.5.1** Ensure that bucket/jaw edge geometry is correct using the bucket/jaw drawing if available. After positioning the lip in its final position, preheat the lip to a temperature between 175°C and 200°C (347°F and 392°F) and proceed with tack welding.

**4.5.2** The temperature between passes must be between 175°C and 230°C (347°F and 446°F) and should be maintained during this step and throughout the rest of the process. To ensure that this temperature is maintained throughout the process, it must be taken at least every half hour.

**4.5.3** The first tack weld must be applied in the center of the bucket/jaw, where the edge of the lip meets the bottom plate of the bucket/jaw. The welding tacks must have a minimum length of 50mm (2") and located every  $X=250\text{mm}$  (10") alternating both sides (inside/outside) from the center of the lip towards the sides of the bucket/jaw.

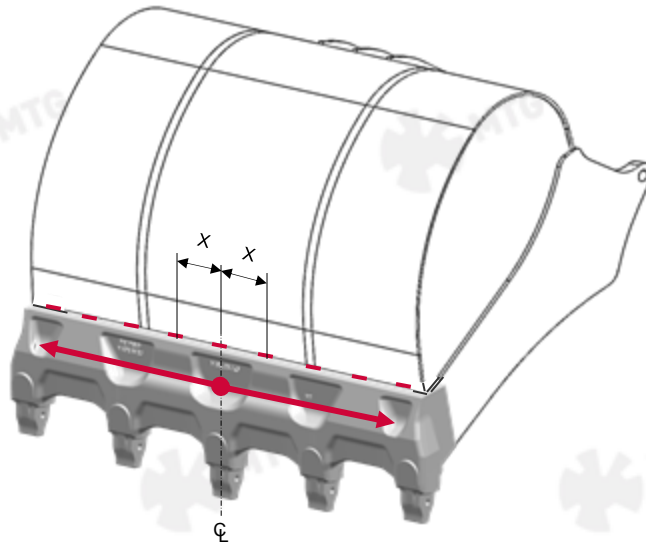

**4.5.4** Do not tack the bucket/jaw cheeks to the lip at this point.

#### **4.6 BEGINNING OF WELDING ON THE REAR LIP EDGE**

**4.6.1** Once the lip has been tack welded to the bucket/jaw, it is time to complete the welding process.

Check that both the lip and the bucket/jaw plates are still at a temperature between 175°C and 200°C (347°F and 392°F). If temperature is below specs, reheat again to the recommended range.

Start with a root pass at the outside of the bucket/jaw. This pass should travel from the center of the lip to the sides, but not reaching them. Do not exceed 250°C (482°F).

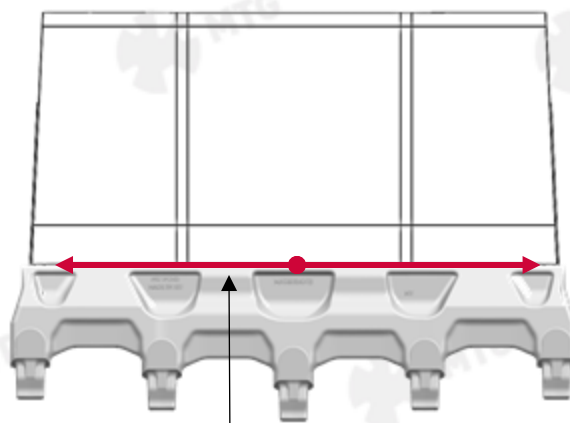

**WELDING ROOT PASS**

**4.6.2** Verify again that the temperature is still between 175°C and 200°C (347°F and 392°F). If temperature is below specs, reheat again to the recommended range.

Apply a root pass inside the bucket. This pass should travel from the center of the lip to the sides, but without reaching them. Do not exceed 250°C (482°F).

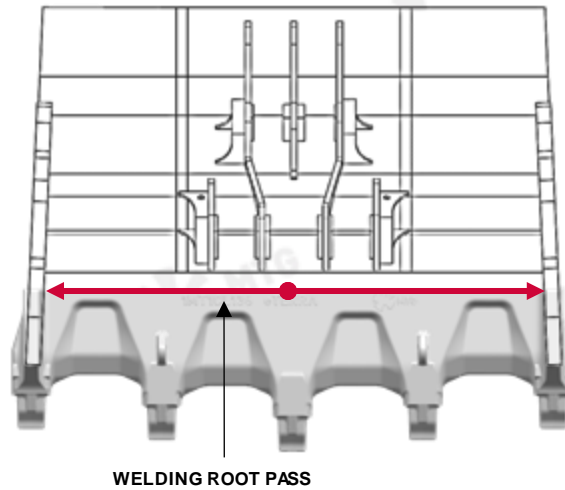

**4.6.3** Weld the rear part of the lip to the bucket/jaw on the outside until completing the half of the weld groove. The welding passes must start in the center of the lip, varying the location of each start and finishing on the sides without reaching them.

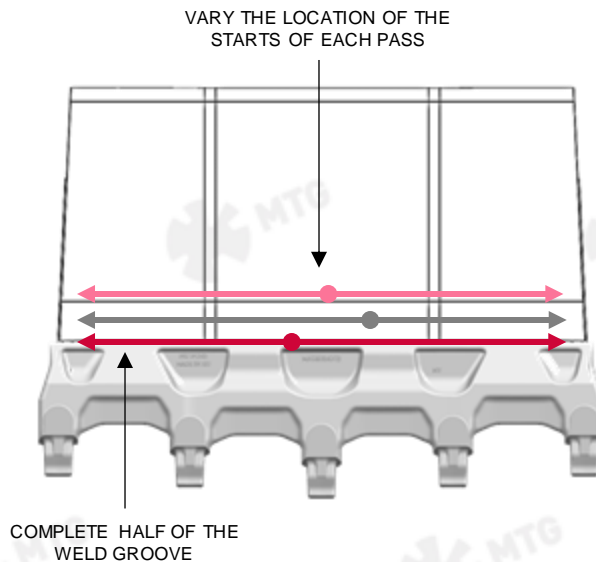



**4.6.4**

Weld the rear part of the lip to the bucket/jaw on the inside until completing the full weld groove. The welding passes must start in the center of the lip, varying the location of each start and finishing on the sides without reaching them.

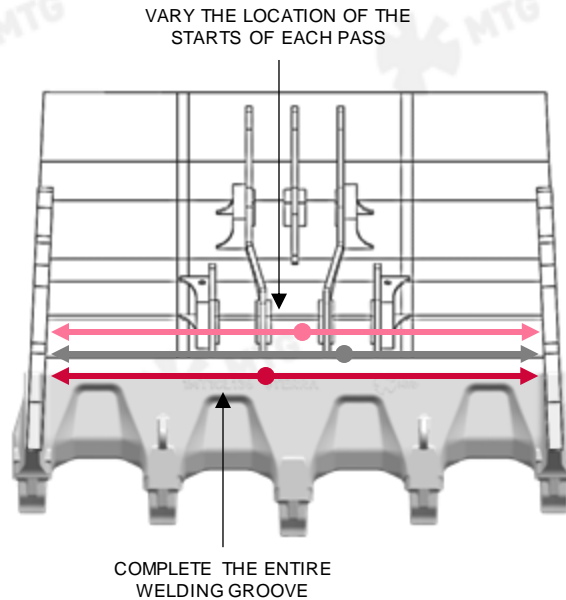

**4.6.5**

Fill the remaining half of the weld groove on the outside of the bucket/jaw. In the same way as before, the welding passes must start in the center of the lip, varying the location of each start and finishing on the sides without reaching them.

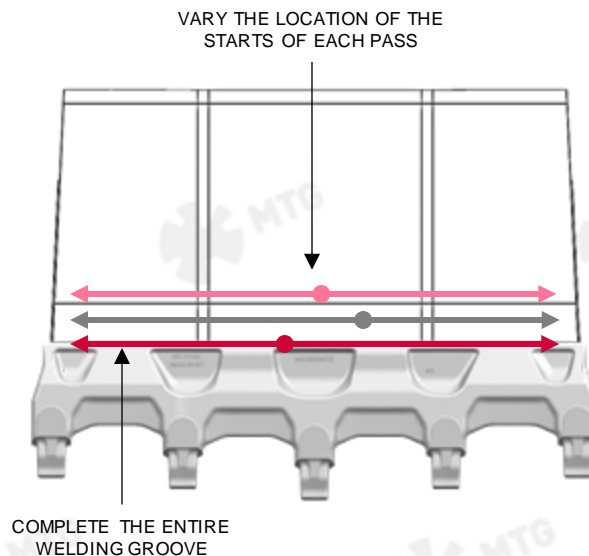

**4.6.6** Once the welding of the rear part of the lip to the bucket/jaw has been completed, it is time to join the sides of the lip to the bucket/jaw.

Position the bucket or jaw in such a way that the lip rests on the ground. This is to be able to perform the next weld in a horizontal position.

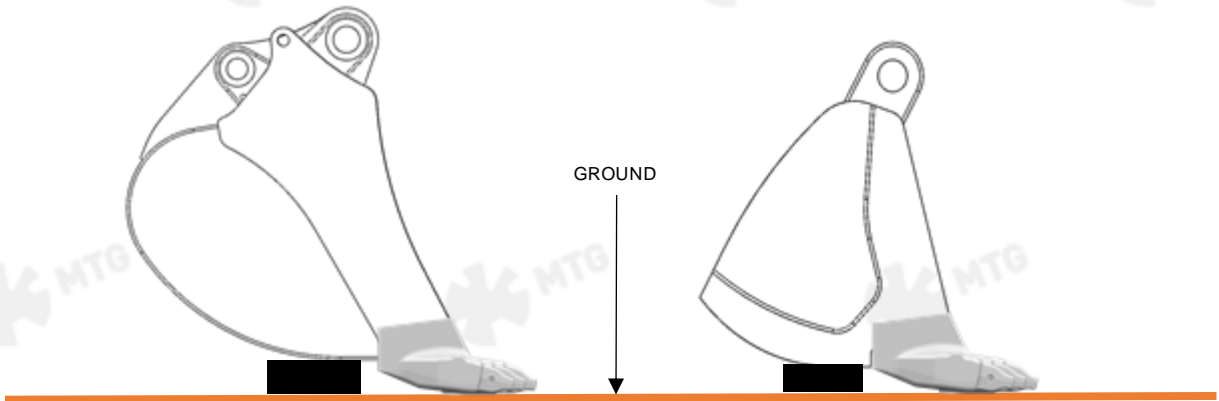

**4.6.7** Before proceeding, verify that the temperature of the area to be welded is still between 175°C and 200°C (347°F and 392°F) within a radius of 100mm (4") around the weld groove. If temperature is below specs, reheat again to the recommended range.

Weld runout tabs on the weld groove, as indicated in the drawing.



**4.6.8** Perform root passes joining the inside of the lip with the inside of the cheek on both sides. Back gouge the root pass from the outside of the bucket. Grind all cleaned surfaces to remove all slag and impurities. Preheat the side of the lip and the bucket between 175°C and 200°C (347°F and 392°F).

**4.6.9** Perform root passes at the outside of the lip side and alternate the passes from the outside to the inside of each side of the bucket/jaw for each weld pass.

**4.6.10** As shown in the figure below, alternate the direction of the passes from the front to the back and from the back to the front of the bucket/jaw for each pass using the runout tabs.

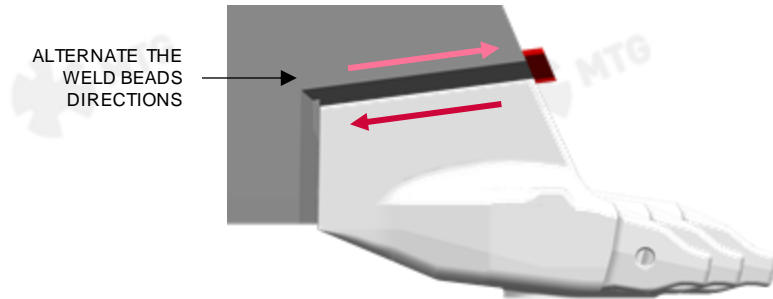

**4.6.11** Continue the welding process until the weld chamfers are completely filled.

**4.6.12** The last weld pass must not be adjacent to the cast lip.

**4.6.13** Proceed in the same way with the other side of the lip.

**4.6.14** Once the welding of the 2 sides of the lip to the bucket or jaw is finished, it is time to finish the welding of the lip by joining the rear part of the side of the lip to the side of the bucket/jaw.

Position the bucket or jaw in such a way that the lip is vertical against the ground. This is to be able to perform the next weld in a horizontal position.

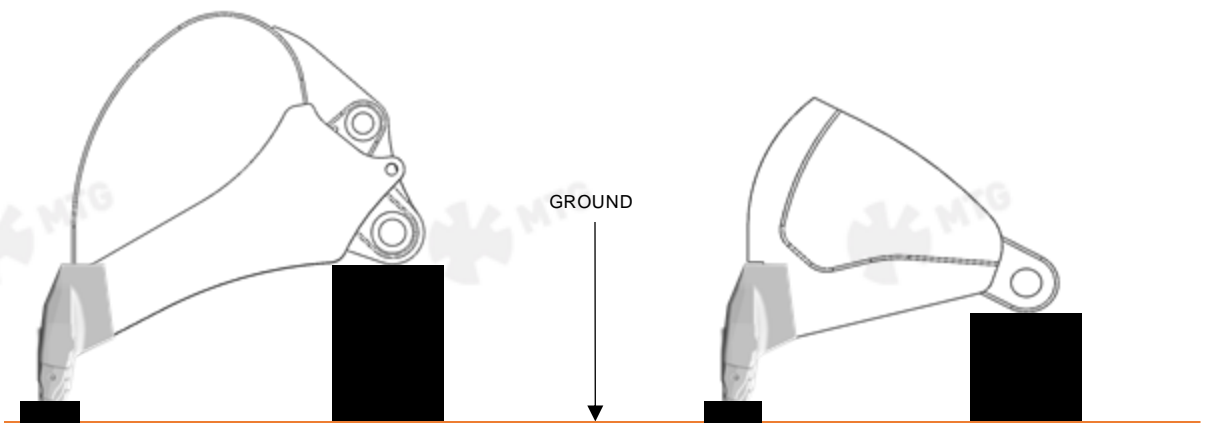

**4.6.15** Before proceeding, verify that the temperature of the area to be welded is still between 175°C and 200°C (347°F and 392°F) within a radius of 100mm (4") around the weld groove. If temperature is below specs, reheat again to the recommended range.

Weld runout tabs on the weld groove, as indicated in the drawing.

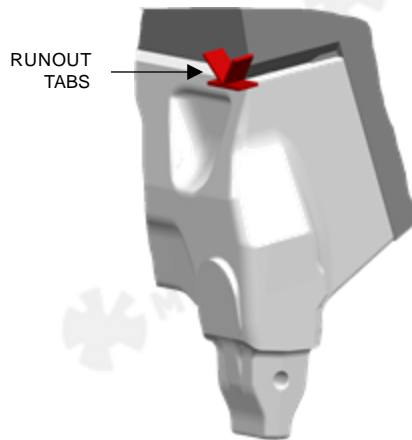

**4.6.16** Perform a root pass joining the inner rear part of the lip with the inner part of the side of the bucket/jaw on both sides. Back gouge the root bead from the outside of the bucket/jaw. Grind all cleaned surfaces to remove all slag and impurities. Preheat the side of the lip and the side of the bucket to a temperature between 175°C and 200°C (347°F and 392°F).

**4.6.17** Perform a root pass on the rear outside of the lip side and on the side of the bucket/jaw. Alternate the weld passes from the outside to the inside of each side of the bucket/jaw for each weld pass.

**4.6.18** As shown in the figure below, alternate the direction of the passes from the front to the back and from the back to the front of the bucket/jaw for each pass using the weld runout tabs .

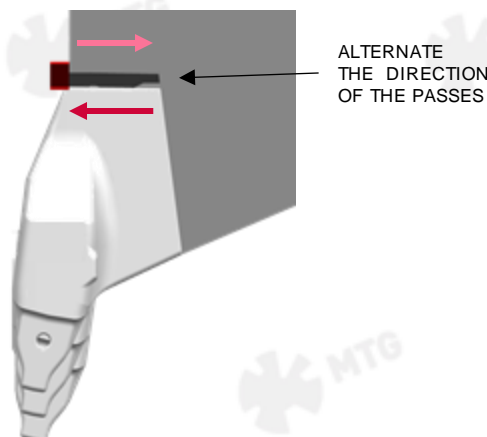

**4.6.19** Continue the welding process until the weld chamfers are completely filled.

**4.6.20** The last weld bead must not be adjacent to the cast lip.

**4.6.21** Proceed in the same way with the other side of the lip.

**4.6.22** After welding completion, a visual inspection of the welds must be performed. Die penetrant or magnetic particles inspection to be conducted after 48h to 72h of the welding completion. Any crack in the welds must be cleaned and repaired.

**4.6.23** Lifting lugs must be removed from castlips after welding is completed and inspected.

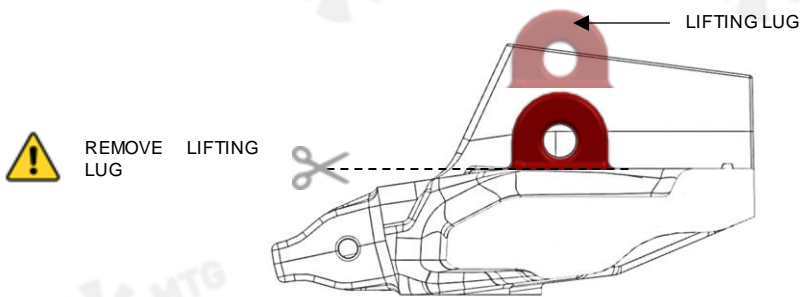



## Service Instructions

The latest welding recommendations and assembly / disassembly instructions can be found online:

[www.mtgcorp.com/manuals](http://www.mtgcorp.com/manuals)

Please contact Technical Services in case of questions:

[technical.services@mtg.es](mailto:technical.services@mtg.es)



---

### MTG HEADQUARTERS

Carrer d'Àvila, 45  
08005 Barcelona (Spain)  
(+34) 93 741 70 00  
info@mtg.es

### MTG NORTH AMERICA

4740 Consulate Plaza Drive  
Houston, TX 77032 (USA)  
+1 (281) 872 1500  
info@mtgcorp.us

### MTG AUSTRALIA

16 – 18 Thorpe Close  
Welshpool, WA, 6106 (AUS)  
+61 8 6248 6513  
Info.australia@mtg.es